

FAG

6000-C-2HRS

Deep groove ball bearing

Schaeffler ID:
0957687420000Deep groove ball bearing 60...-C-2HRS,
single row, Generation C, seals, steel
sheet metal cage

Technical information

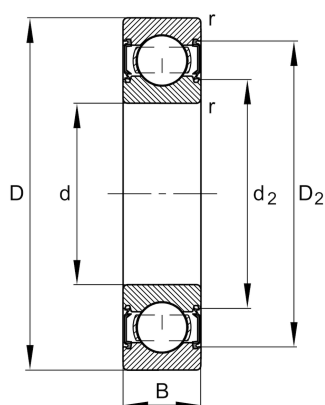
**Main Dimensions & Performance Data**

d	10 mm	Bore diameter
D	26 mm	Outside diameter
B	8 mm	Width
C_r	5.300 N	Basic dynamic load rating, radial
C_{0r}	1.970 N	Basic static load rating, radial
C_{ur}	136 N	Fatigue load limit, radial
n_G	28.500 1/min	Limiting speed
	0,018 kg	Weight

Dimensions

r_{min}	0,3 mm	Minimum chamfer dimension
D_2	23,1 mm	Caliber diameter outer ring
d_2	13,7 mm	Caliber diameter inner ring

Mounting dimensions

d_{amin}	12 mm	Minimum diameter shaft shoulder
D_{amax}	24 mm	Maximum diameter of housing shoulder
r_{amax}	0,3 mm	Maximum fillet radius

Calculation factors

f_0	12,4	Calculation factor
-------	------	--------------------

Temperature range

T_{min}	-20 °C	Operating temperature min.
T_{max}	100 °C	Operating temperature max.

